









A		1
B		1
C		2
D		1

①		3
②		6
③		6
④		4
⑤		1

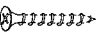

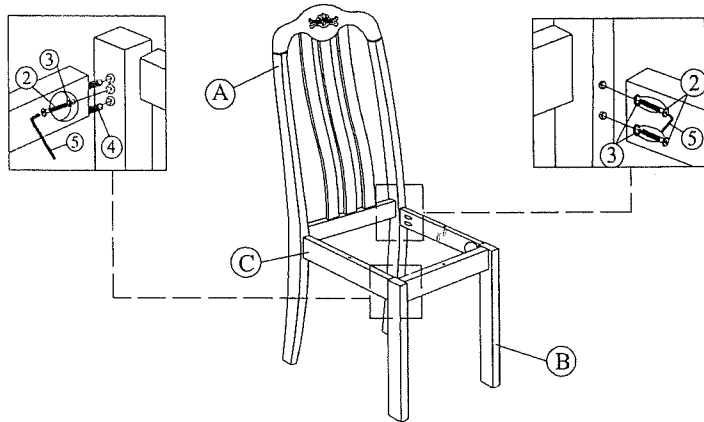

MODEL:



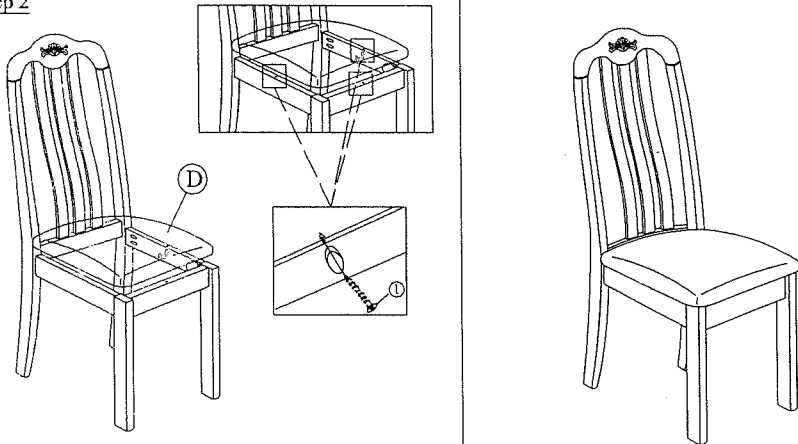

Step 1



Step 2

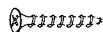

A		1
B		1
C		2
D		1

①		3
②		6
③		6
④		4
⑤		1

MODEL:

Step 1

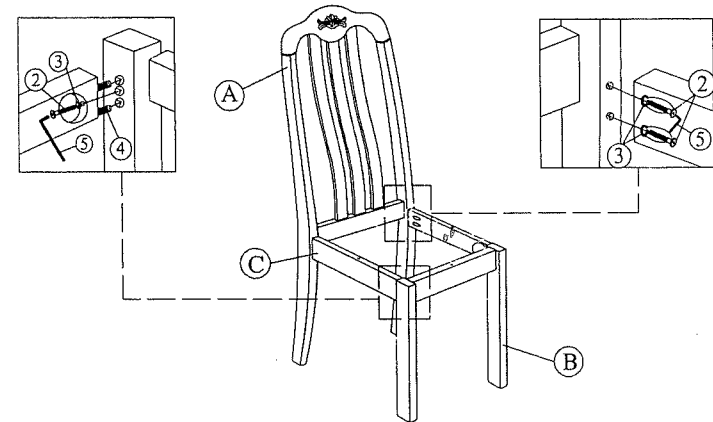

Step 2

